

Lincat

User and Installation Instructions

Seal Refrigerated Merchandisers

C6R/75, C6R/100, C6R/105, C6R/125,
C6R/130, D6R/100, D6R/125, D5R/100,
D5R/125, D3R/100

Please make a note of your product details for future use:

Date Purchased: _____

Model Number: _____

Serial Number: _____

Dealer: _____













SEAL

Dear Customer,
Thank you for purchasing this Lincat product.

This is just one of over 300 different items of catering equipment available which is constantly being extended and improved. Details are available from your local distributor or direct from us.

Used for the purposes for which it is intended, and with careful maintenance as outlined in this User Guide, your **Lincat** product will give years of trouble free use.

IMPORTANT INFORMATION

	Please read all of the safety and operating instructions carefully before using this product. Please pay particular attention to all sections of this User Guide that carry warning symbols and notices.
	This is a Warning symbol. This symbol is used throughout the user guide whenever there is a risk of personal injury. Ensure that these warnings are read and understood at all times.
	This is a Caution symbol. This symbol is used throughout the User Guide whenever there is a risk damaging your Lincat product. Ensure that these warnings are read and understood at all times.
	Make sure the power supply is turned off before making any electrical repairs.
	To minimise shock and fire hazards, please do not plug or unplug the unit with wet hands.
	During maintenance and cleaning, please unplug the unit where required.
	Care must be taken when handling or working on the unit as sharp edges may cause personal injury, we recommend the wearing of suitable PPE.
	Ensure the correct moving and lifting procedures are used when relocating a unit.
	Do NOT use abrasive cleaning products, only those that are recommended. Never scour any parts of the refrigerator. Scouring pads or chemicals may cause damage by scratching or dulling polished surface finishes.
	Failure to keep the condenser clean may cause premature failure of the motor/compressor, which will NOT be covered under warranty policy.
	Please ensure the appropriate use of safety aids or Personnel Protective Equipment (PPE) are used for you own safety.
	This is a Note symbol. This symbol is used throughout the User Guide to provide additional information, hints and tips.
	<p style="text-align: center;">DISPOSAL REQUIREMENT</p> <p>If not disposed of properly all refrigerators have components that can be harmful to the environment. All old refrigerators must be disposed of by appropriately registered and licensed waste contractors, and in accordance with national laws and regulations.</p>

CONTENTS

<i>Contents</i>	<i>Page</i>
Safety instructions	4
Product specification	5
Features	5
Technical specification	5
Pack contents	6
Spare parts list	6
Installation	7
<i>Note to installer</i>	7
<i>Inspection</i>	7
<i>Handling</i>	7
<i>General</i>	7
<i>Connecting to the electricity</i>	7-8
<i>Warning</i>	8
<i>User Maintenance</i>	8
<i>Defrosting</i>	8
<i>Warning</i>	8
<i>Loading</i>	8
Installation Instruction for C6R-U	9
Details of C6R-U cabinets	10
Details of cut-out for refrigeration module	11
Ventilation requirement for counter top models	12
Wiring Diagrams	13-14-15
Troubleshooting	16-17-18
Operating instructions	19
<i>Cabinet Controls</i>	19
<i>Loading</i>	19
Cleaning and maintenance	20
<i>Cleaning the condenser</i>	20
<i>Replacing the light</i>	20
Service information	21
Conditions of guarantee	21

USE OF THE REFRIGERATED MERCHANDISERS

The Refrigerated Merchandisers are intended to be used on counter tops to display pre-chilled food product.

SAFETY INSTRUCTIONS

WARNING!



Basic safety precautions, including the following, should be followed to reduce the risk of personal injury and/or damage to the cabinet. Make sure you have fully read these instructions before installing and switching on. Keep this User Guide in a safe place for future reference for you and your staff.

Do not clean the unit with a water jet.

REMOVAL OF PACKAGING



Remove any external packaging. If using a sharp instrument take care to avoid contact with the product inside. In the interest of hygiene, you should clean the product after unpacking and ensure all plastic coatings are removed before use.



This unit is heavy. Be aware of the risks when lifting or moving it. Always lift the cabinet using the base or lower frame, do not lift with any other part. Do not pull the unit across your work surface as it may make a mark.



The cabinet relies on the circulation of cold air, which must pass through and around the shelves. Ensure circulation is not obstructed by food product blocking the internal vents.

GENERAL

Do not try to modify this product.

Ensure that the electrical supply cable is not damaged. If the supply cable is damaged, it should be replaced by Lincat Ltd or suitably qualified persons, in order to avoid a hazard.

PRODUCT SPECIFICATION

**650 Range Refrigerated Merchandiser – C6R/75, C6R/100, C6R/105,
C6R/125, C6R/130
D6R/100, D6R/125**

500 Range Refrigerated Merchandiser – D5R/100, D5R/125

350 Range Refrigerated Merchandiser – D3R/100

FEATURES

**Fan-assisted refrigeration
Double glazed glass (flat panels)
Electronic control
Hot gas automatic defrost
Sliding rear doors (double glazed)**

**Independently switchable light
Adjustable shelf positions (back
service models only)
230 Volt, 50 Hz, single phase**

TECHNICAL SPECIFICATION

Model		D3R/100	D5R/100	D5R/125	D6R/75	D6R/100	D6R/125
Max. Operating Temperature	°C	25					
Internal volume	litres	85.8	127.3	172.2	226.6	306.4	386.2
Internal dims	cm	710x310x390	710x460x390	960x460x390	710x570x560	960x570x560	1210x570x560
Width	mm	1000	1000	1250	750	1000	1250
Depth	mm	350	500	500	650	650	650
Height	mm	575	575	575	965	965	965
Power Rating	watt	393	602	621	602	717	729
Weight	kg	68	84	100	95	123	149.5
Refrigerant		R404a					

Model		C6R/75	C6R/100	C6R/105	C6R/125	C6R/130
Max. Operating Temperature	°C	25				
Internal volume	litres	226.6	306.4	226.6	386.2	306.4
Internal dims	cm	710x570x560	960x570x560	710x570x560	1210x570x560	960x570x560
Width	mm	750	1000	1050	1250	1300
Depth	mm	650	650	650	650	650
Height	mm	755	755	755	755	755
Power Rating	watt	602	717	604	729	717
Weight	kg	89.5	117	105	137.5	112.2
Refrigerant		R404a				

PACK CONTENTS

C6R/105, C6R/130, D6R/100, D6R/125 Models

Refrigerated Merchandiser (with cable and 13amp plug)
 2 x chrome-plated shelves
 2 x removable base panels
 2 x sliding doors

3mm Allen key (for shelf height adjustment)
 User Guide
 Guarantee card

C6R/75U, C6R/100U, C6R/125U Drop-in Models

As above, plus drop-in refrigeration module

D5R/100, D5R/125, D3R/100 Models

As above, except 1 x chrome plated shelf and removable base plate.

SPARE PARTS LIST

Model	Components					
	Compressor	Light	Controller	Evaporator fan	Condenser Fan Motor	Shelf
D3R/100	CR08	LA01	EC15	S/R0181	FA109	SH93
D5R/100	CR08	LA01	All Models	All Models	FA109	SH91
D5R/125	CR07	LA05			FA109	SH92
D6R/75	CR08	LA01			FA109	SH97
D6R/100	CR07	LA05			FA109	SH98
D6R/125	CR07	LA05			FA109	SH99
C6R/75	CR08	LA01			FA109	SH97
C6R/100	CR07	LA05			FA109	SH98
C6R/105	CR08	LA01			FA109	SH97
C6R/125	CR07	LA05			FA109	SH99
C6R/130	CR07	LA05			FA109	SH98

INSTALLATION

All models (For C6R/75U,C6R/100U,C6R/125U Models see additional instructions)



Note to installer

Please follow this instruction carefully. Only if the cabinet is correctly installed will it give the best possible performance and reliability. Please pay particular attention to the User maintenance section of this guide that the controller must be left on the factory setting. There are also clear guidelines stating that the grill on cabinet must not be blocked at any time and condenser must be cleaned every 3 months. There are no user serviceable parts inside the refrigerated compartment.

Inspection

On receipt, unpack the carefully and inspect for any superficial damage that may have been sustained in transit. Record the nature of any damage on the Carrier's Delivery Note and at the same time inform your supplier.

Handling

Important: Keep the cabinet vertical and on its base, if the cabinet is tipped onto its back, front or sides allow it to stand back on its base for at least 2 hours before switching ON.

Ensure the cabinet is installed on a sound, level work surface, observing requirements for ventilation as detailed on pages 10,11 & 12. Do not install this cabinet close to any source of heat which may result in operating conditions exceeding its design limits. Locations close to sources of moisture or steam will cause excessive condensation on the outer surfaces of the cabinet and must be avoided.

Ambient temperature range; minimum 18°C, maximum 25°C Maximum relative humidity 60%.

General



Installation must only be carried out by a suitable trained person and comply with national and local codes for connection to electrical supply. **The cabinet must be earthed... the earthing of the installation a safety standard, which is enforced by law. Do not switch on the unit the installation has been completed.**



Connecting to the electricity supply

The cabinet is completely factory wired and only needs to be connected to a suitable power point (socket). It is recommended that the mains electricity supply is protected by an RCCB (Residual current circuit breaker). Cabinets are supplied with 2 metres of cable and should be connected to an earthed, switched, 13 amp 230Volts socket which should be easily accessible for isolation of the cabinet.

The socket should be installed in accordance with current I.E.E regulations. If in doubt consult a qualified electrician. The 1989 Electricity at work Regulation requires periodic testing of electrical equipment and should be carried out by a competent person.

The cabinet are designed for indoor use only in ambient temperature between minimum 18°C, maximum 32°C. The cabinet must be positioned on a flat level surface. To reduce energy consumption position the cabinet in a well ventilated location, away from sources of heat. It should not be exposed to water spillage. Spray steam or high humidity. Failure to do so may reduce the efficiency of the cabinet and increase the frequency of maintenance required. Particular attention should be paid to airflow restriction into and out of the refrigeration system, this is very important for the cabinet to operate efficiently.

Ensure that the voltage of your electricity supply corresponds to the serial plate details. The product is supplied with a 13 Amp plug. To replace the plug, follow these instructions:

- green and yellow wire to 'E' or (Earth)
- blue wire to 'N' (Neutral)
- brown wire to 'L' (Live)

For safety regulations, the plug must always be accessible.

THIS APPLIANCE MUST BE EARTHED

Warning



Under no circumstances must the power supply be switched ON and OFF in quick succession over a short period. To do this could result in serious damage to the compressor, causing failure of refrigeration system. Having completed the electrical connection, the cabinet can be switched 'On' at the mains. When the unit is first switched 'ON' you will hear condenser fan motors running and the compressor, evaporator fan will come 'On' when the evaporator is cooled to correct temperature. The temperature inside the cabinet is controlled by mean of electronic controller, which is factory set and should not need any adjustment. The cabinets are designed to be left ON at all times, like a domestic refrigerator Ensure the door of the cabinet remain closed when not being used. Failure to do so will reduce the efficiency of the refrigeration system and may cause excess condensation or ice build up on the evaporator.

User Maintenance

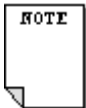

Due to electrical regulation only a very limited amount of user maintenance work can be carried out. There are no user serviceable parts inside the refrigeration compartment.

Please note- No cleaning or maintenance work should be attempted until the cabinet is switched off and the plug removed from the socket.

Only use genuine Lincat spares. All parts numbers are listed on the Spares list on page 6 for easy ordering when required.

Defrosting

The Seal Refrigerated Merchandises are fitted with an automatic defrost function ensuring the cooling heat exchanger remains free from ice. The condensate water is automatically dispersed using the heat from the refrigeration unit.

Loading



When loaded ensure that air can circulate around / through store products. Cover all foods and separate raw and cooked food. Do not allow items to overhang the edges of the shelves.

INSTALLATION INSTRUCTIONS FOR C6R/75U, C6R/100U, C6R/125U DROP-IN MODELS

Refer to the information on page 4 before proceeding.

The cabinet is not connected to the refrigeration module during transit. Remove the doors, shelves and base panels from the cabinet and lift this from the pallet first to separate the two parts of the appliance.

Prepare the counter taking note of the ventilation requirements on page 11.

Cut a hole in the counter top according to the diagram (2) on page 10. Lift the refrigeration module onto the counter top so that the electrical supply cable is on the customer's side. Lower through the hole and ensure that the cable is not trapped.

Carefully lower the cabinet over the refrigeration module and onto the counter top ensuring the cables are not trapped. The plinth around the base of the cabinet must be fully supported by the counter top beneath; no part of this plinth should be allowed to overhang the counter top.

Open the evaporator box back lid, connect cables to terminal blocks (see diagram below)

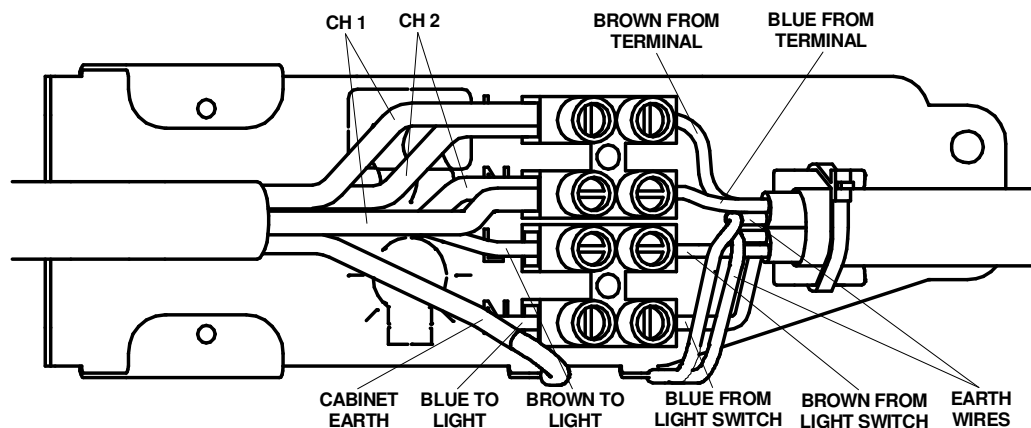

Using the screw supplied secure the terminal lid and hinged lid. Replace base panels, shelves and doors.

The cabinet is now ready for use
Refer to operating instruction on page 19.

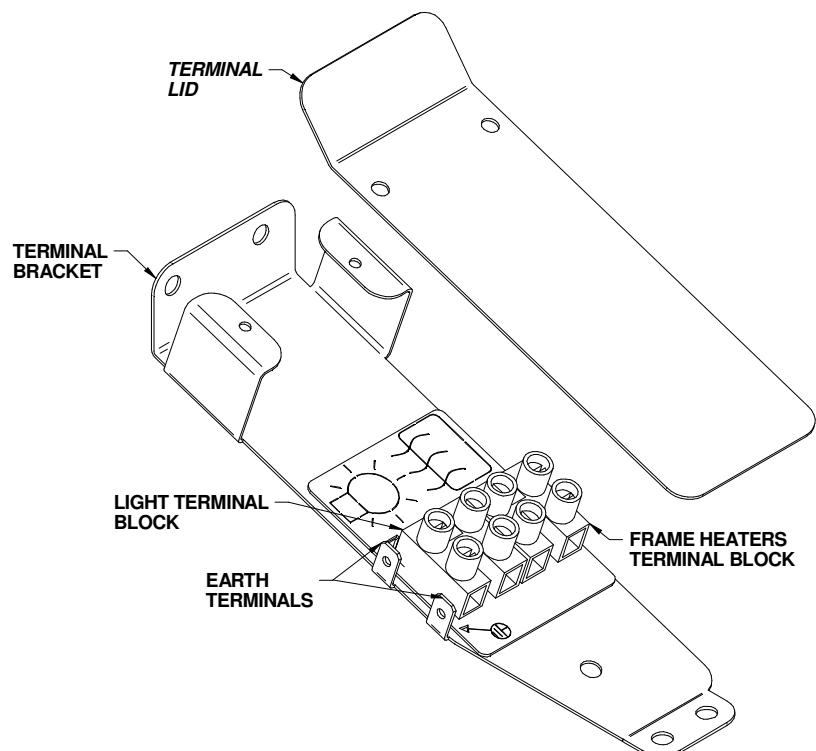

Details of the base section and cabinet (1)

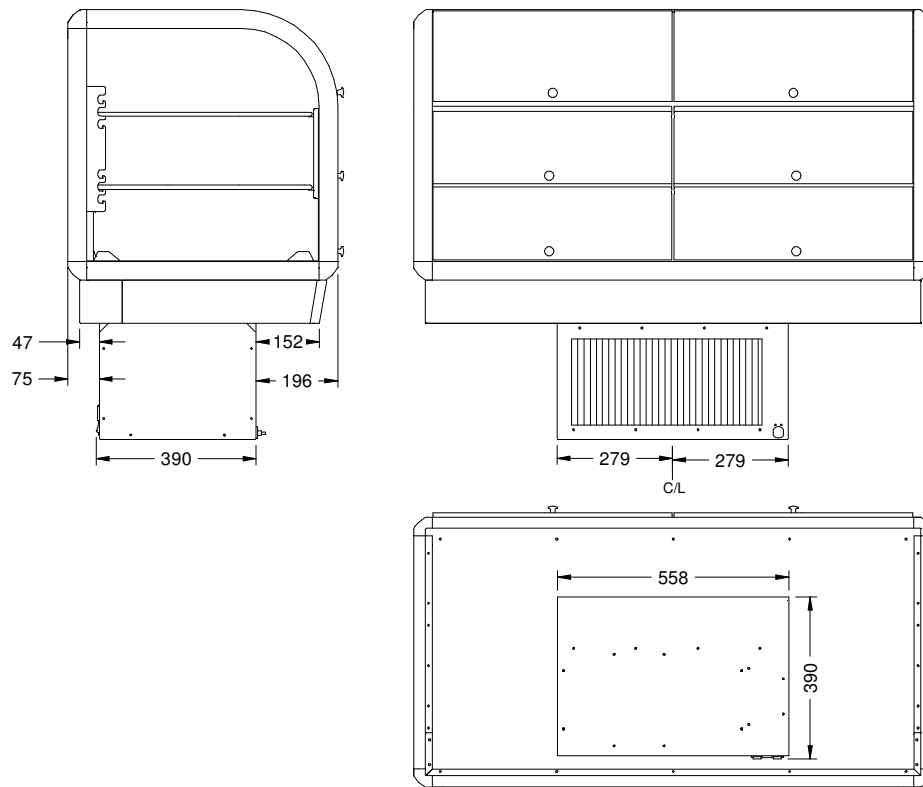

Details of cut-out for refrigeration module (2)

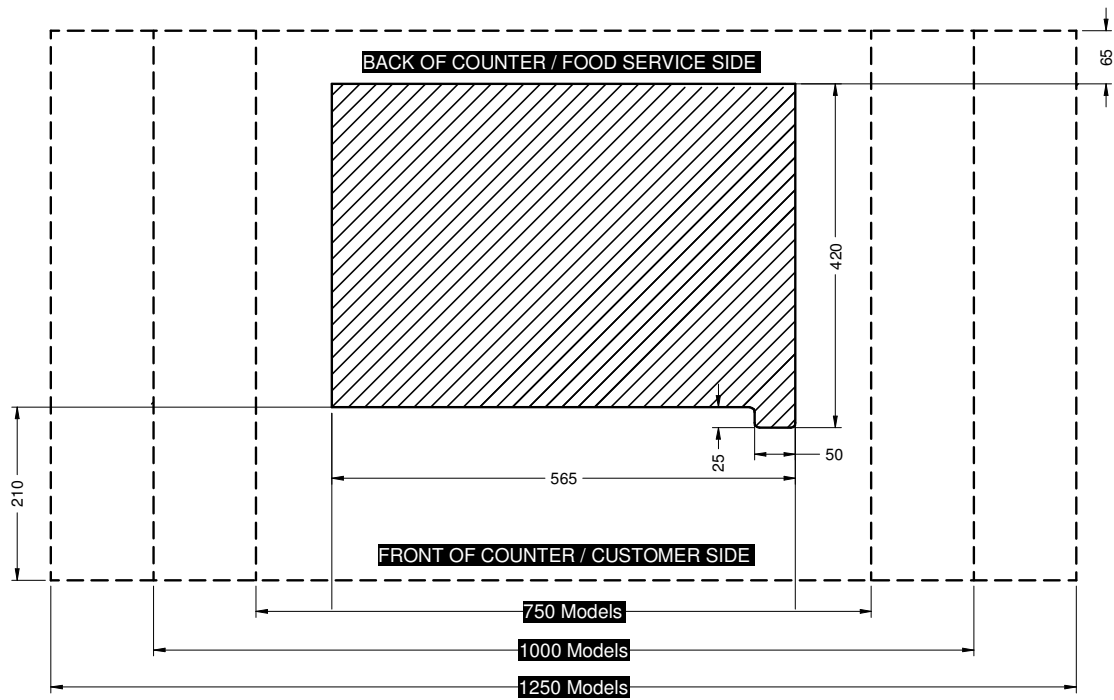

Ventilation requirements for drop in models

It is crucial for the operation of the refrigeration system that a free flow of air is maintained around condensing unit.

The ideal method is to site the cabinet within a counter where the back is completely open as Fig 1.

These cabinets are designed to eliminate the need for an unsightly vent on the front of the counter providing that the critical dimensions in Fig 2 are observed and there are no obstructions in front of the air exhaust that may be deflected into the path of the incoming cold air.

Fig 1

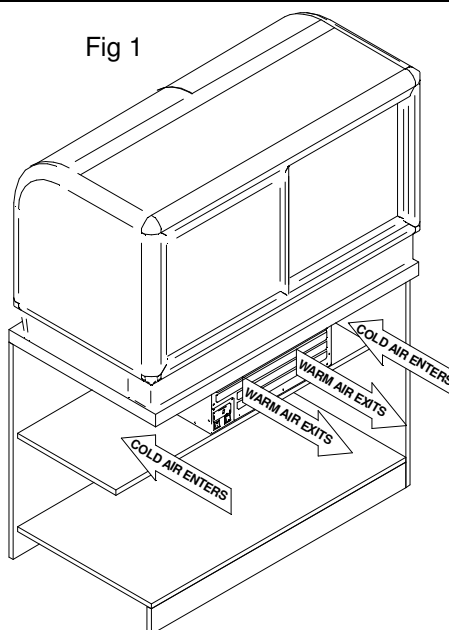

The dimension X from the front grille of the condenser to the inner face of the counter front must not be less than 200mm.

If a shelf is required in the counter it must allow adequate air flow beneath the unit, dimension Y must be no less than 200mm.

Fig 2 demonstrates how the air must flow through the condenser to extract the heat.

Fig 2

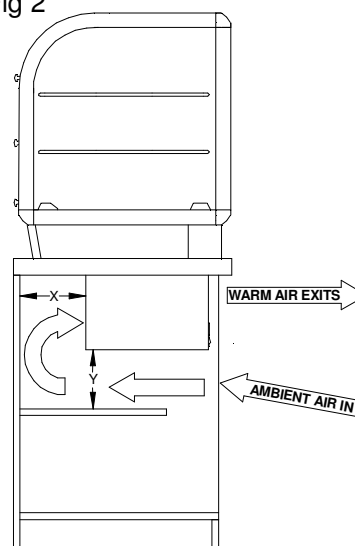

To guarantee a flow of cool air particularly where the back counter is warm, then adequate vents can be provided in the front of counter (see Fig3) to ensure the refrigeration system will only work satisfactorily.

The air inlet vents should be aligned with condenser aperture and have total free area greater than 900cm².

The air outlet also should be aligned with power pack condenser air outlet grill and have total free area greater than 1000cm².

Fig 3

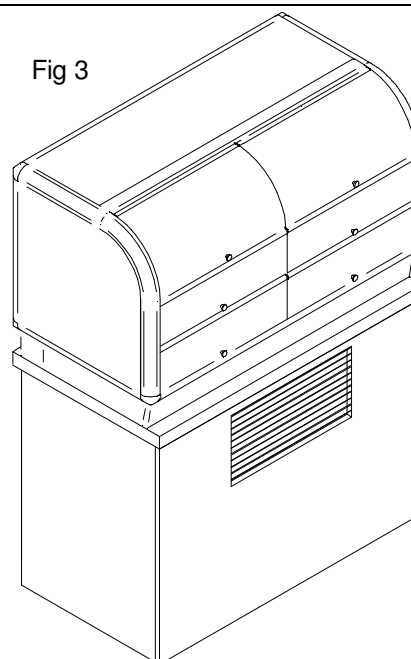

Ventilation requirements for counter top models

Minimum distance of vents from any adjacent wall or surface

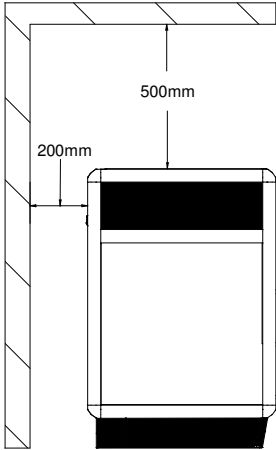
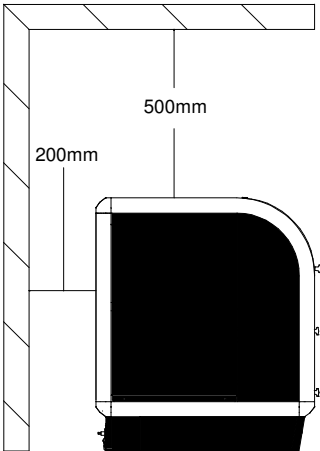
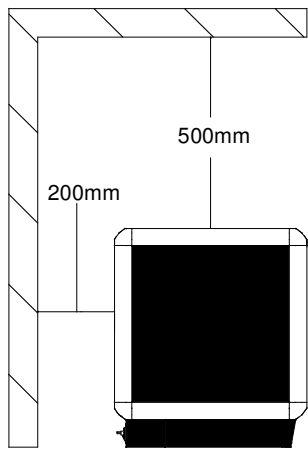
<p>D6R/75B & S D6R/100B & S D6R/125B & S</p>	 <p>A technical diagram showing a side view of a counter top model with a vent. The vent is a dark rectangular area at the top of the unit. Dimension lines indicate a 200mm clearance from the left wall to the vent and a 500mm clearance from the ceiling to the vent.</p>
<p>C6R/105BL & BR C6R/105SL & SR C6R/130BL & BR C6R/130SL & SR</p>	 <p>A technical diagram showing a side view of a counter top model with a vent. The vent is a dark area with a rounded top-right corner. Dimension lines indicate a 200mm clearance from the left wall to the vent and a 500mm clearance from the ceiling to the vent.</p>
<p>D5R/100B & S D5R/125B & S D3R/100</p>	 <p>A technical diagram showing a side view of a counter top model with a vent. The vent is a dark rectangular area at the top of the unit. Dimension lines indicate a 200mm clearance from the left wall to the vent and a 500mm clearance from the ceiling to the vent.</p>

WIRING DIAGRAM C6R75-100-125-U

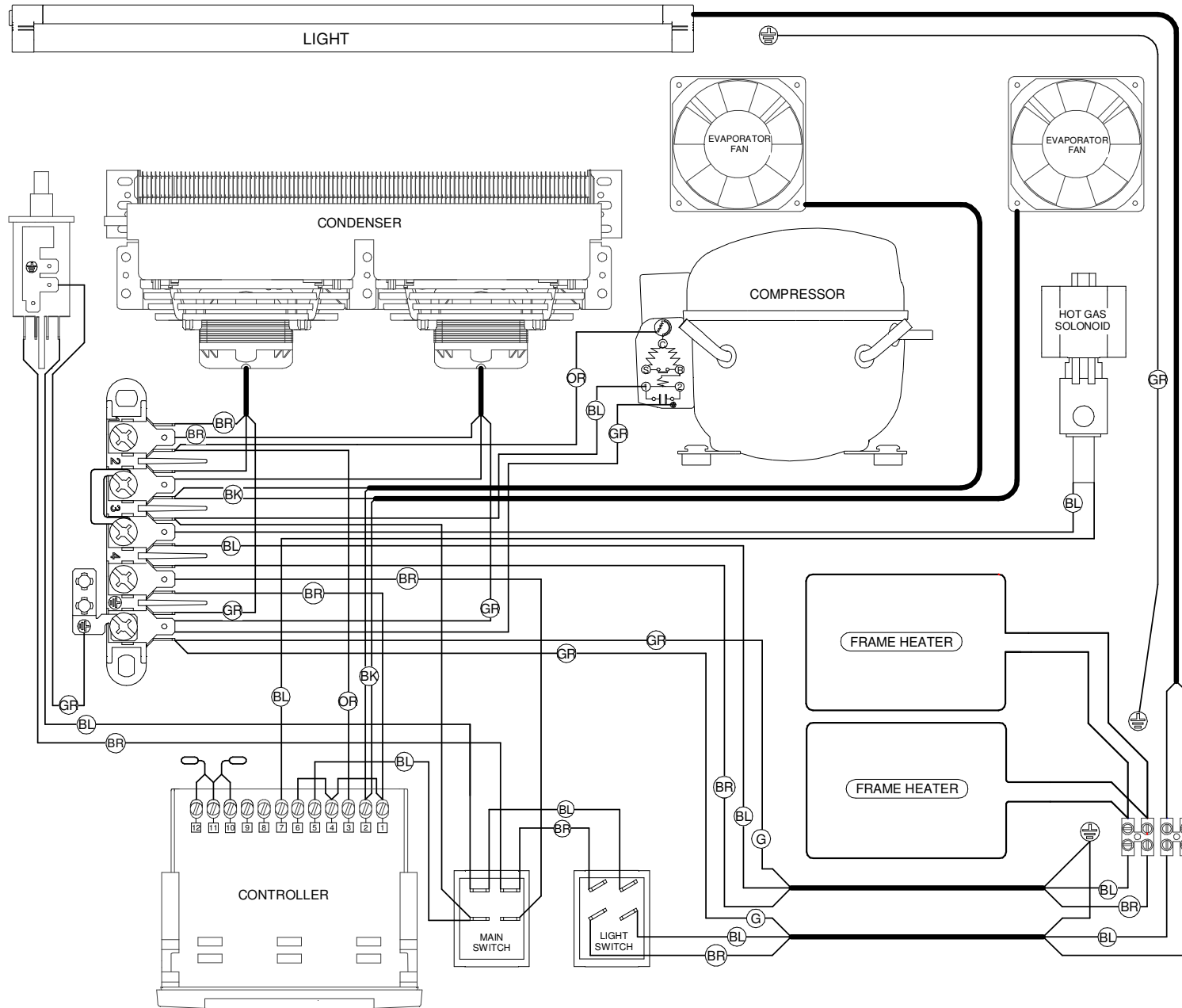



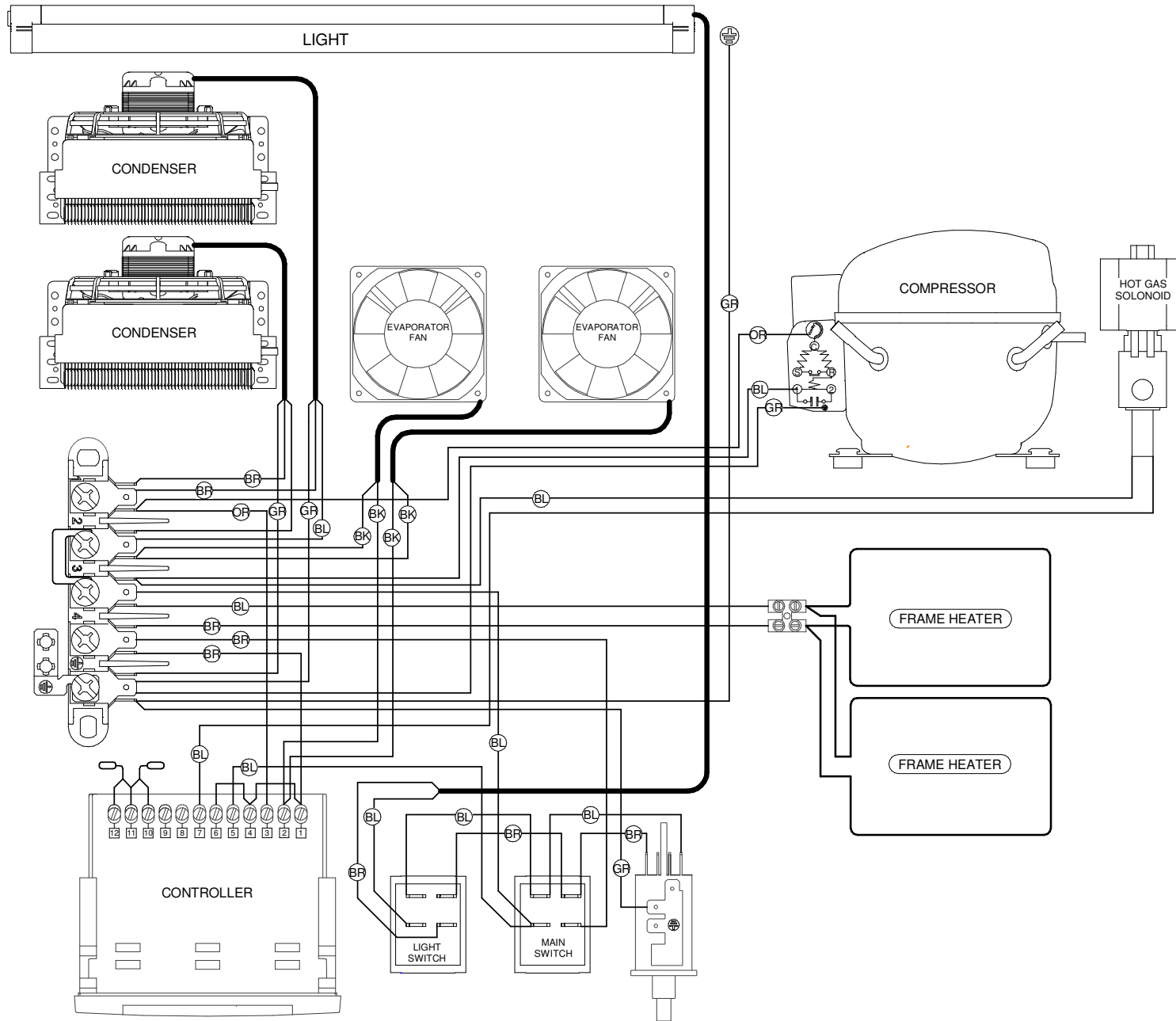



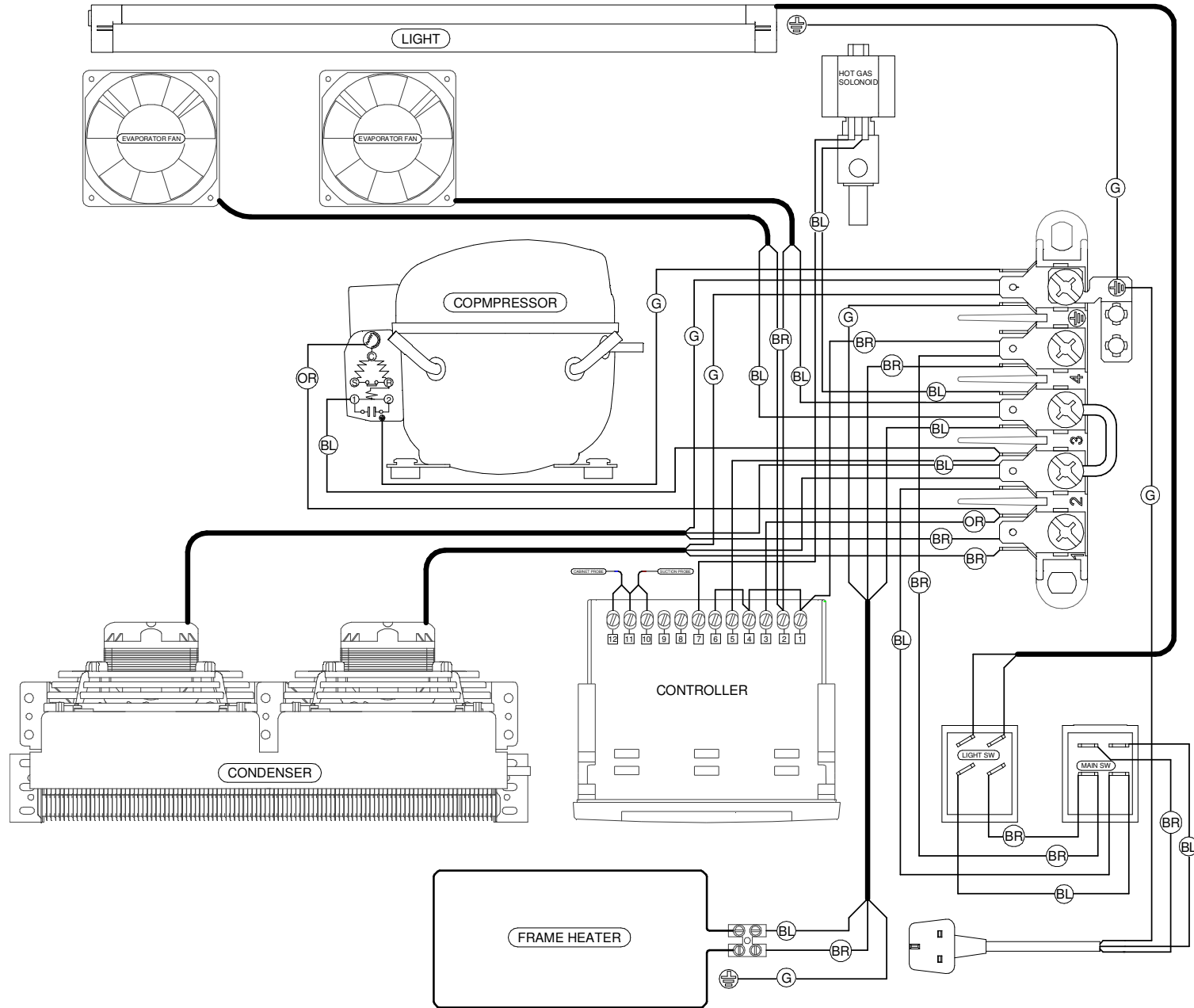



WIRING DIAGRAM C6R105-130













WIRING DIAGRAM D6R75-100-125



Troubleshooting

Problem	Possible Cause	Solution
Compressor will not start  	No voltage in socket	Use voltmeter to check
	Electrical conductor or wires may be cut	Use ohmmeter to check for continuity
	Defective electrical component: controller, relay, thermal protector etc	Replace defective component
	Compressor motor has a winding open or shorted	Measure ohmic resistance of main and auxiliary winding using ohmmeter. Compare with correct values Change compressor
	Compressor stuck	Change compressor
	Temperature control contacts are open	Replace the controller
	Incorrect wiring	Check wiring diagram and correct
	Fuse blown or circuit breaker tripped.	Replace fuse or reset circuit breaker
	Mains Power cable unplugged	Plug in main power cable
	Controller set too high	Set controller to lower temperature.
Cabinet in defrost cycle	Wait for defrost cycle to finish	
The temperature is too cold	Controller is set at a very cold position	Set to factory parameter and check if the compressor stops according to controllers operating range.
	Controller does not disconnect the condensing unit	Check the insulation of the controller and probe(s). If problem persists, change the controller and probe
	Control contacts are stuck closed	Change the control. Check amperage load
	Defective or incorrect temperature controller	Determine correct controller and replace.
The temperature is not cold enough 	Controller is set at a very warm position	Set to factory parameter and check if the compressor stops according to controllers operating range
	Condenser is dirty	Clean condenser
   	The refrigerator has been placed at an inadequate location	The unit must not be near stoves, walls that are exposed to the sun, or places that lack sufficient air flow.
	Compressor is inefficient or there is a high pressure due to the air in the system	If there is air in the system, purge and recharge
	Iced up evaporator coil	Check temperature control, refrigerant charge, and defrost mechanism. Remove all ice manually and start over.
	Too many door openings	Advise user to decrease if possible
	Excessive heat load placed in cabinet	Advise user not to put in products that are too hot.
	Excessive heat load placed in cabinet	Advise user not to put in products that are too hot.
	The refrigerator has been overcharged with the refrigerant gas	Check to see if condensation or ice crystals have formed on the suction line. If so, charge with the correct amount of gas.

    	The refrigerant gas is leaking	Find the location of gas leak in order to seal and replace the defective component. Change the drier. Perform a good vacuum and recharge unit.	
	The refrigerant gas is leaking	Find the location of gas leak in order to seal and replace the defective component. Change the drier. Perform a good vacuum and recharge unit.	
	Blocking air flow	Re-arrange product to allow for proper airflow. Make sure there is ample of clearance around the product	
	Fuse blown or circuit breaker tripped	Replace fuse or reset circuit breaker.	
Electrical Shocks		Wires or electrical components are in direct contact with metallic parts. Check for appropriate insulation on the connections of each component.	
Noise		The refrigerator is not properly levelled	Check if the noise goes away after you level the refrigerator
	The condenser is not fastened correctly. Copper tubing is in contact with metal	While the compressor is working, check to see if metal parts are in contact with one another and/or if the screws that fasten the condenser are tightened.	
	The evaporator and/or condenser fan motors are loose	Check if the fan motors are securely fastened	
	Compressor has an internal noise	If the noise persists after all other measures have been taken, it may be originating from the compressor.	
	Loose component(s)	Locate and tighten loose component(s)	
Extreme condensation inside the refrigerator	The outside environment's relative humidity is very high (over 60%)	This type of occurrence is caused by local climatic conditions and not by the refrigeration unit.	
	The refrigerator door won't shut completely	Check the door and/or the magnetic gasket. Adjust the door hinges if needed; replace the gasket if broken.	
	The refrigerator had been placed at an inadequate location	The unit must not be near sources that produce too much heat.	
  	Door seals(s) not sealing properly	Ensure gaskets are snapped in completely. Remove gasket and wash with soap and water. Check condition of gasket & replace if necessary	
	Dirty condenser coil	Clean condenser coil	
	Evaporator coil iced over	Unplug unit and allow coil to defrost. Make sure controller is not set too cold. Ensure that door gasket(s) are sealing properly. Select manual defrost and ensure system works.	
No illumination	The light switch is 'off' position	Press the light witch to 'ON' position	
	False contact on the light switch or fluorescent tube	Inspect all connections	
	Light assembly ,light switch and/or fluorescent tube are damaged	Replace the damaged components	

OPERATING INSTRUCTIONS

1. On/Off Switch
2. Light Switch
3. Temperature Control

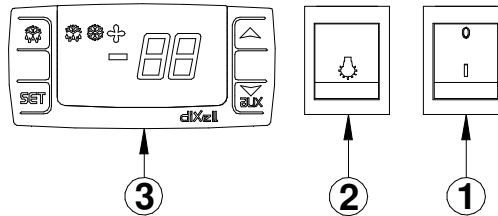

The control panel layout may vary.

Ensure shelves are secure. Close the doors. To check operation of the unit, connect it to the electricity supply, switch on the light (2) and the light will illuminate, and then switch on the refrigeration using the On/Off switch (1), the temperature controller will illuminate and the cabinet will begin to cool.

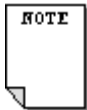

The temperature controller is factory set to maintain the temperature inside at 3 to 5°C. The temperature displayed is the air inside the cabinet and not the temperature of the food product.

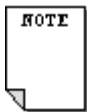

The displayed temperature will fluctuate as the refrigeration system cycles. At 2 hour intervals the system will automatically defrost. You will hear a hissing sound for a few seconds and the display will indicate that it is in defrost mode, refer to page 13.

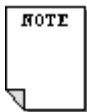

LOADING

Load the cabinet with pre refrigerated products only, taking care to allow room for the air to flow. Do not allow items to overhang the edges of the shelves.



Do not obstruct any of the ventilation grilles.

CLEANING AND MAINTENANCE

CLEANING



Disconnect the unit from the electricity supply. Use a mild detergent in hot water and a soft cloth. Do not use abrasive creams or scourers. Remove the rear doors, shelves and base panels. Shelves (including supports) and base-panels may be washed in a dishwasher.

MAINTENANCE

Regular cleaning of the unit is recommended. No other regular maintenance is required, but it may be necessary to clean the condenser or replace a light tube.

CLEANING THE CONDENSER

Disconnect the unit from the electricity supply.

For counter top models the condenser is located behind a grille on the operator side of the appliance. Access the condenser by removing the screw holding the grille in place using the Allen key provided. Use a vacuum cleaner to suck any debris from the face of the condenser and replace the grille.

For drop in models the condenser is located at the front of the drop in module and can be brushed down using a stiff bristled brush.

REPLACING THE LIGHT



Disconnect the unit from the electricity supply.

Remove doors. Unclip the end caps from the light unit. Remove the diffuser from its clips. To remove the tube, carefully rotate it 90° and slowly pull down until it is released. It is recommended that the starter (a round cylinder located at one end of the tube) is also replaced at the same time. To remove the starter, rotate it anticlockwise. Fitting the new tube is the reverse of the above sequence.

SERVICE INFORMATION

For help with the installation, maintenance and use of your **Lincat** equipment, please contact our service department:

☎ UK: 01522 875520

All service work, other than routine cleaning should be carried out by one of our authorised service agents. We cannot accept responsibility for work carried out by other persons.

To ensure your service enquiry is handled as efficiently as possible, please tell us:

- Brief details of the problem
 - Product code
 - Type number
 - Serial number
- } All available on serial plate

Lincat reserve the right to carry out any work under warranty, given reasonable access to the appliance, during normal working hours, Monday to Friday, 08:30 to 17:00.

GUARANTEE

This unit carries a comprehensive UK mainland twelve month / 2 year warranty. The guarantee is in addition to, and does not diminish your statutory or legal rights.

The guarantee does not cover:

- Accidental damage, misuse or use not in accordance with the manufacturer's instructions
- Consumable items
- Damage due to incorrect installation, modification, unauthorised service work or damage due to scale, food debris build-up, etc.

The manufacturer disclaims any liability for incidental, or consequential damages.

Attendance is based on reasonable access to the appliance to allow the authorised technician to carry out the warranty work.

Service calls to equipment under warranty will be carried out in accordance with the conditions of sale. Unless otherwise specified, a maximum of 15 minutes of administrative time, not spent directly carrying out servicing work, is provided for within the warranty. Any requirement for staff attending the call to spend greater time than 15 minutes due to administrative requirements, such as on health and safety risk assessments, will be chargeable at the prevailing rate.